

Transmission Identification

Ford C4, 65-96 (3 speed)

Ford C-4

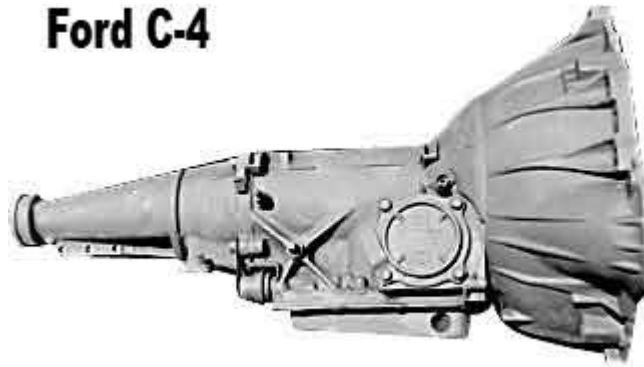
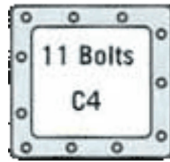

Ford FMX, 68-80, (3-Speed)

Ford FMX

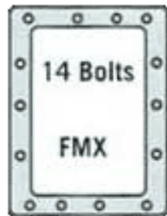

Ford C6, 66 and newer (3 speed)

Ford C-6

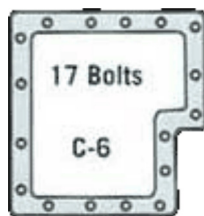

Ford AOD, 80-91 (Overdrive)

Ford AOD

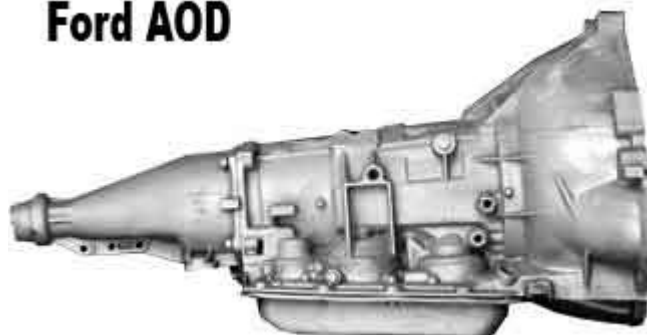
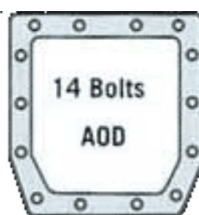

GM Turbo 2004R 81-90 (Overdrive)

GM 2004R

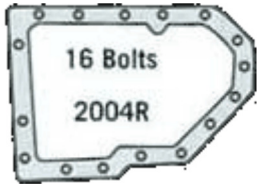

GM Powerglide 62-73 (2 speed)

GM Powerglide

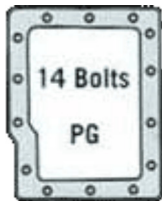

GM 700R4, 82-92 (Overdrive)

GM 700R4 (4L60) & 4L60E

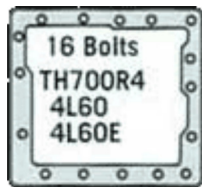

GM 4L80E, 91 and newer (Overdrive)

GM 4L80E

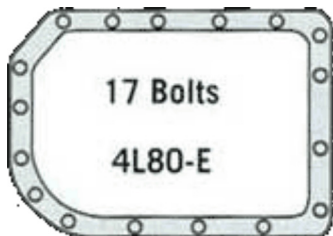

GM Turbo 400, 65 and newer (3 speed)

GM Turbo 400



GM Turbo 350, 69-86 (3 speed)

GM Turbo 350

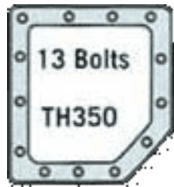

GM TH200, 76-89

GM Turbo 200



Chrysler 727

Chrysler 727

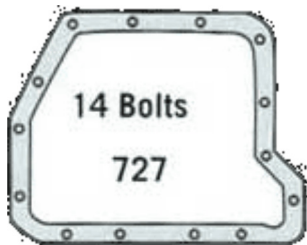

Chrysler 904, 60 and newer (3 speed)

Chry 904

